



Think Automation and beyond...



Relay Sockets
SU series



One step wiring
Easy & quick connection

IDEC CORPORATION



Push-in

Time saving & efficient

Save up to **55%** in wiring time

Wiring time reduced greatly compared with conventional screw terminals.

(Compared with IDEC products)

Reduce maintenance work

Push-in terminals eliminate the need for torque maintenance such as tightening of screws because screws are not used.

Push-in
SU Series

Conventional
Screw terminal

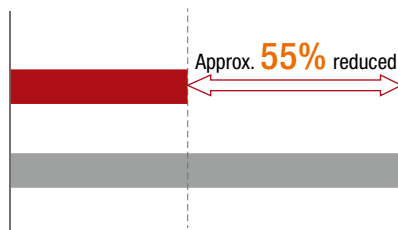

*) Based on IDEC research

Retightening
required



Screw terminal

No retightening

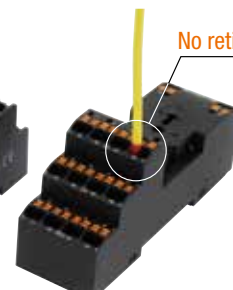

Push-in

Wide range of options

Easy wiring to coil side connection using jumpers

Can be used with polarized relays.



*) The rated current is 2A.

IDEC GT5Y timers can be mounted

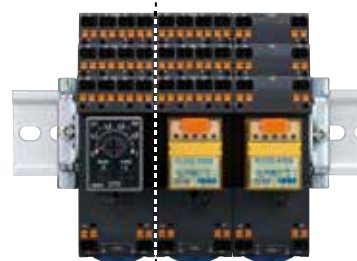

GT5Y timer | RU relay

Marking plate allows for easy identification

A marking plate enables easy identification of connections. Maintenance time is reduced.

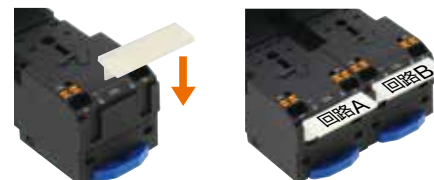

One step wiring, easy & quick connection

Safe and efficient SU series Push-in relay sockets



Highly reliable

High visibility

The terminal number on the socket can be clearly seen on the socket preventing incorrect wiring. Also, the distinct color pusher prevents a flat blade screw-driver from being inserted into the wire port.

Vibration-resistant

Safe and reliable Push-in connection achieves high contact reliability and vibration resistance regardless of the wire size or shape.



Before inserting wire



Wire inserted

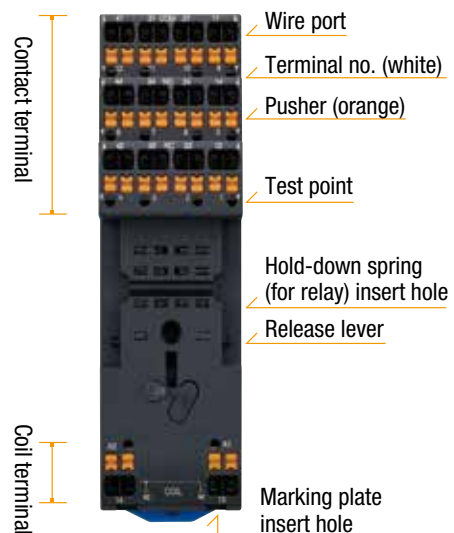

IP20 Finger-safe

IEC60529 finger-safe design. IP20 protection. Safe contact protection structure prevents electric shock.

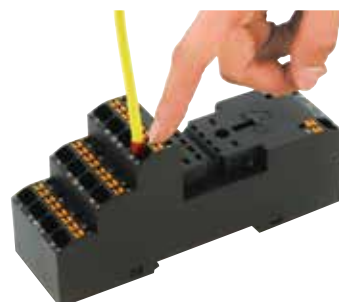

Release lever

The release lever can be mounted to hold and remove the relay easily.



SU Series Relay Sockets

Push-in relay sockets reduce wiring by 55%*

* Compared with conventional screw terminal relay sockets.

Relay Sockets

Package Quantity: 1

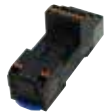
Shape	No. of Poles	Part No. (Ordering No.)
	2	SU2S-21L
	4	SU4S-21L

Applicable Relay / Timer

No. of Poles	Socket	Relay	Timer
2	SU2S-21L	RU2S, RN2S	GT5Y-2
4	SU4S-21L	RU4S, RU42S, RN4S	GT5Y-4

- For details on RU series relay, RN series relay, and GT5Y timer, see catalog.
- When using the SU socket with RU series relay, be sure to note the derating characteristics.

Derating Curve

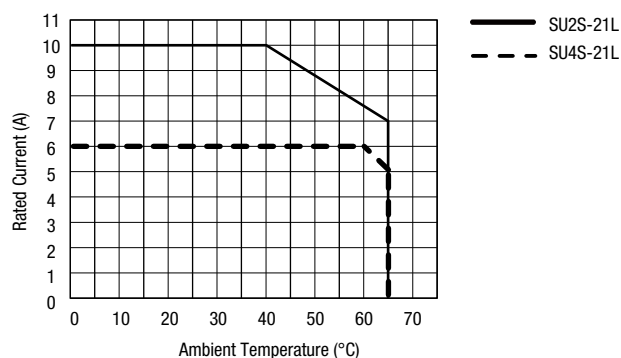

Specifications and Ratings

Part No.	SU2S-21L	SU4S-21L
No. of Poles	2	4
Rated Insulation Voltage	300V AC/DC	
Rated Thermal Current (*1)	12A	8A
Applicable Wire	Solid wire / stranded wire: 0.14 to 1.5mm ² , AWG26 to 16 Stranded wire with ferrule (without insulated cover): 0.5 to 1.5mm ² , AWG20 to 16 Stranded wire with ferrule (with insulated cover): 0.14 to 1.0mm ² , AWG26 to 18	
Insulation Resistance	100MΩ min. (500V DC megger)	
Dielectric Strength	2500V AC, 1 min. (between live and dead metal parts, between live metal parts of the different poles)	
Vibration Resistance (Damage Limits)	10 to 55 Hz, amplitude 1.0 mm	
Shock Resistance (Damage Limits)	50G (when using SU9Z-S21R/-S21T hold-down spring or SU9Z-C21R release lever)	
Operating Temperature	-40 to +65°C (no freezing)	
Operating Humidity	5 to 85% RH (no condensation)	
Storage Temperature	-40 to +65°C (no freezing)	
Storage Humidity	5 to 85% RH (no condensation)	
Degree of Protection	IP20 (IEC 60529)	
Weight (approx.)	80g	
Applicable Standards	UL508, CSA C22.2 No.14, IEC61984	

*1) Be sure to note the derating characteristics.

Dimensions

SU2S-21L

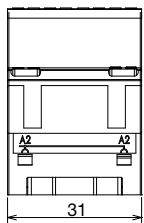
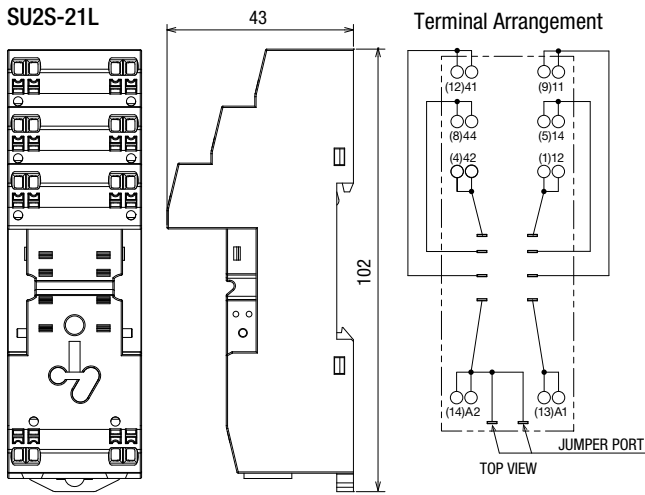

SU4S-21L

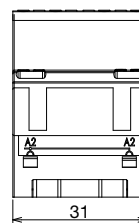
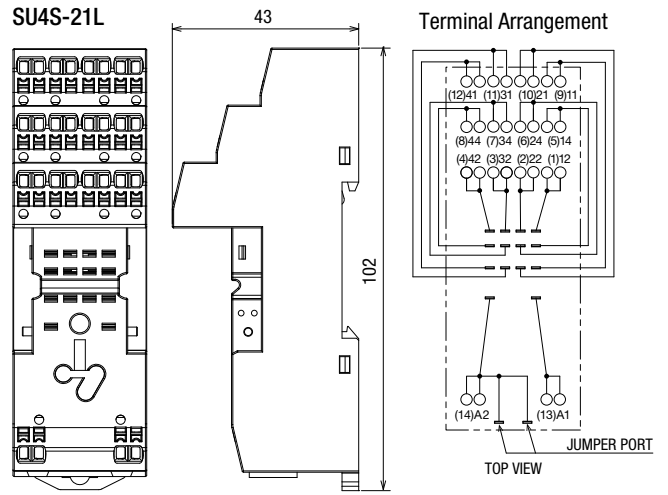

All dimensions in mm.

Note) The numbers in parentheses () are values according to NEMA standards.

Accessories

When ordering, specify the Ordering No.

Function	Shape	Material	Part No.	Ordering No.	Package Quantity	Remarks
Release Lever (For Relay)		Plastic	SU9Z-C21R	SU9Z-C21R	5	<p>Note) Release lever cannot be used on timers.</p>
Marking Plate		Plastic (white)	SU9Z-P2100W	SU9Z-P2100W	10	
Jumper		Bronze (tin-plated) Insulation: PBT plastic	SU9Z-J2102A	SU9Z-J2102A	10	A2 terminal of the coil is connected. The rated current is 2A.
Hold-down Spring	For Relay	Stainless steel	SU9Z-S21R	SU9Z-S21R	10	See P.8 for Applicable Relay / Timer.
	For Timer	Stainless steel	SU9Z-S21T	SU9Z-S21T	10	
DIN Rail		Aluminum	BAA1000	BAA1000PN10	10	<ul style="list-style-type: none"> Length: 1m Width: 35mm Weight: 200g (approx.)
End Clip		Metal (zinc-plated steel)	BNL6	BNL6PN10	10	Weight: 15g (approx.) Use end clips when mounting multiple sockets on the DIN rail.
DIN Rail Spacer		Plastic (black)	SA-406B	SA-406B	1	Thickness: 5 mm Used for adjusting spacing between sockets mounted on a DIN rail.

Instructions

Identifying the Socket

SU2S and SU4S can be identified by the part number marked on the side.

No. of Poles	Part No.
2	SU2S-21L
4	SU4S-21L

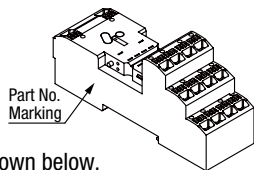

Applicable Wire

When wiring, use the applicable wires shown below.

Applicable Wire and Specifications

Applicable Wire (Stranded Wire, Solid Wire)	0.14 to 1.50mm ² (AWG16 to 26)
Wire Strip Length (*1)	10 to 11mm

*1) Strip the sheath of the wire 10 to 11 mm from the end.

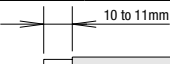

When using a ferrule, refer to "Wire Size and Recommended Ferrule" below.
 Note: Make sure that the stranded wires do not loosen when using wiring without ferrules.

Wire Size and Recommended Ferrules

Ferrules without Insulated Covers

Applicable Wire (Stranded Wire)		Wire Strip Length	Weidmüller Recommended Part No.
AWG	mm ²		
20	0.50	10 to 11 mm	H0.5/10
18	0.75	10 to 11 mm	H0.75/10
18	1.00	10 to 11 mm	H1.0/10
16	1.50	10 to 11 mm	H1.5/10

Note) Above ferrules cannot be purchased from IDEC.

Ferrules with Insulated Covers

Applicable Wire (Stranded Wire)		Wire Strip Length	IDEC Part No.
AWG	mm ²		
26	0.14	10 to 11 mm	S3TL-F014-12WC
24	0.25	10 to 11 mm	S3TL-H025-12WJ
22	0.34	10 to 11 mm	S3TL-H034-12WT
20	0.50	10 to 11 mm	S3TL-H05-14WA
		12 to 13 mm	S3TL-H05-16WA
18	0.75	10 to 11 mm	S3TL-H075-14WW
		12 to 13 mm	S3TL-H075-16WW
18	1.00	10 to 11 mm	S3TL-H10-14WY
		12 to 13 mm	S3TL-H10-16WY

Recommended Crimping Tool (Optional)

Item	Crimping Range	IDEC Part No.
Crimping tool	0.5 to 4mm ² / 30AWG to 12AWG	S3TL-CR04T
	0.25 to 6mm ² / 24AWG to 10AWG	S3TL-CR06D

Note) Note the crimping dimensions when using tools other than the recommended crimping tool. For details, see page 7.

Recommended Screw driver (Optional)

Name	IDEC Part No.
Flat blade screwdriver	S3TL-D04-25-75

Note) Use a flat blade screwdriver with a blade size of 0.4×2.5mm. Refer to the table below for other companies' ferrules that correspond to "Wire Size and Recommended Ferrules".

Applicable Wire (Stranded Wire)	PHOENIX CONTACT Part No.		WAGO Part No.		
	Without Insulated Cover	With Insulated Cover	Without Insulated Cover	With Insulated Cover	
26	0.14	—	AI 0.14-8 GY-1000	—	
24	0.25	—	AI 0.25-8 YE	—	
22	0.34	—	AI 0.34-8 TQ	—	
20	0.50	A 0.5-8	AI 0.5-8 WH	FE-0.5-8	FE-0.5-8N-WH
		A 0.5-10	AI 0.5-10 EH	FE-0.5-10	FE-0.5-10N-WH
18	0.75	A 0.75-8	AI 0.75-8 GY	FE-0.75-8	FE-0.75-8N-GY
		A 0.75-10	AI 0.75-10 GY	FE-0.75-10	FE-0.75-10N-GY
18	1.00	A 1.0-8	—	FE-1.0-8	—
		A 1.0-10	—	FE-1.0-10	—
16	1.50	A 1.5-10	—	FE-1.5-10	—

Note) Check each company's catalog for details.

Parts Description

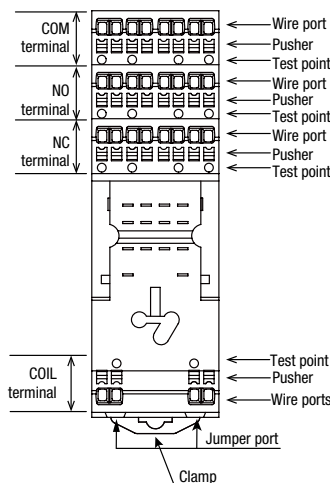

Note: Two wire ports for each terminal

Inserting the Wire

Wire with ferrule or solid wire

- 1) Insert the wire to the back of the wire port.
- 2) Wiring is complete. Pull the wire lightly to make sure that the wire does not pull out from the socket.

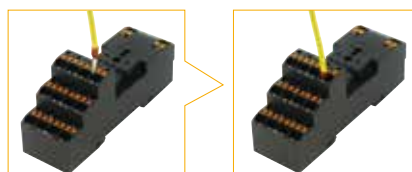

Stranded wire

- 1) Push the pusher (orange button) using a flat blade screwdriver.
- 2) Insert the wire fully in the wiring port while pressing the pusher
- 3) Release the flat blade screwdriver. Wiring is complete. Pull the wire lightly to make sure that the wire does not pull out from the socket.



Removing the Wire

- 1) Push the pusher using a flat blade screwdriver.
- 2) Pull out the wire while pressing the pusher.
- 3) Release the flat blade screwdriver.

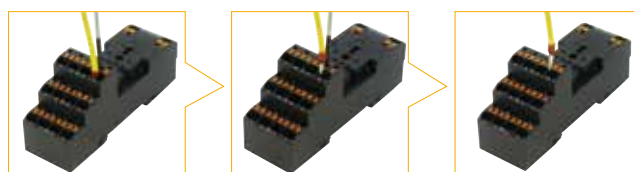

Instructions

Note

- After wiring, tug lightly to make sure that the wire is properly connected.
- Operate the pusher with a force of 40N. Do not press excessively.
- Do not pull the wire out without depressing the pusher. When pulling the wire, be sure to pull in a straight direction. Otherwise, the socket may be damaged.
- Use a recommended flat blade screwdriver with the blade size of 0.4×2.5mm.
- When mounting multiple sockets on a DIN rail, be sure to secure both side with end clips (BNL6).

Crimping of Ferrules and Wiring

- Choose an appropriate ferrule for the wire.
- Cut the wire carefully to get a flat end.
- Make sure that ferrule sleeve is completely filled by the conductor. Depending on the cross section, the conductor should protrude approx. 0 to 1 mm from the ferrule sleeve.

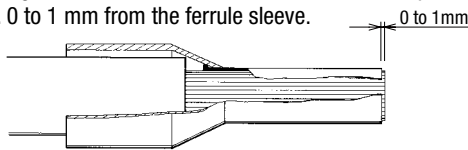

- When crimping, refer to the instructions of the crimping tool.

Crimping dimensions: W2.4×H1.9 mm

Maximum connectable crimping size is W2.4×H1.9. Make sure that the ferrule size will be smaller than this dimension.

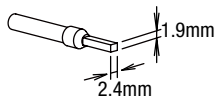

Note 1) If a tool other than the recommended crimping is used, the ferrule may not be crimped to the appropriate size and the clamp or spring inside the socket may be deformed and may not operate normally.

Note 2) Pin crimp terminals cannot be used.

Installing the Hold-down Spring

Use SU9Z-S21R (for relay) or SU9Z-S21T (for timer) hold-down springs. Install the hold-down springs into appropriate spring insert hole. To install, see below diagram.

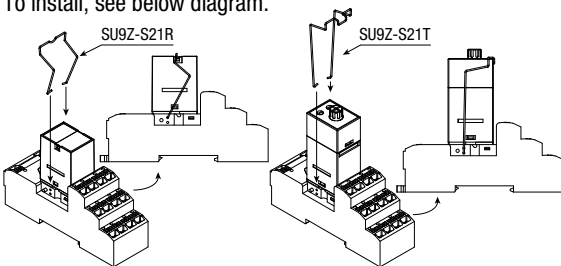

Note) Confirm that the Hold-down Spring is securely installed into the spring insert hole. The relay may fall off if it is not installed properly.

Installing / Removing the Relay

Installing the Relay

1. Unlock the release lever by pulling down as shown with arrow ①.
2. Press the relay against the socket as shown with arrow ②. Make sure that the relay is firmly in place.

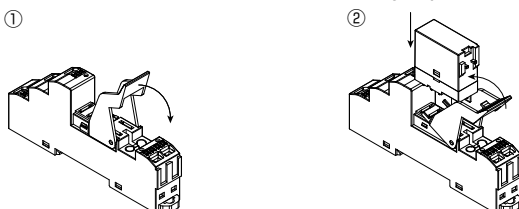

Note: Confirm that the relay is securely installed in the socket. The relay may fall off if it is not installed properly.

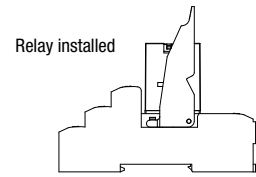

Removing the Relay

Lightly press the relay to prevent it from falling off. Then pull down the release lever to the direction shown by the arrow and the remove the socket.

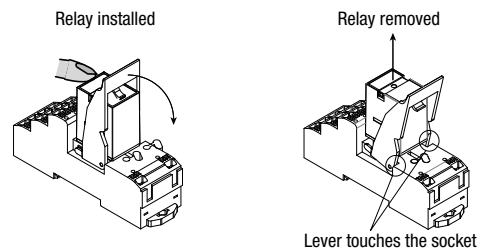

Note)

- Make sure that wire or finger is not caught between the release lever and socket.
- Because release lever is removable, make sure not to apply excessive force. Otherwise the relay may fall and result in damage.

Installing the Marking Plate

Install the marking plate as shown in the diagram below. Mark on the surface using an oil-based marker, or affix a sticker with markings.

The size of the marking surface is 8.4mm × 25mm.

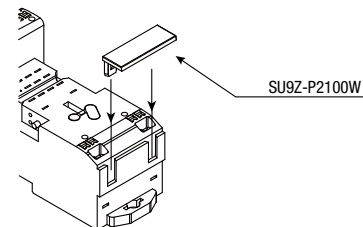

Using the Jumper

Insert the jumper to the back of the jumper slot. To remove, insert the small flat blade driver into the slot below and pull out. Because the rated current is 2A, use at 2A maximum.

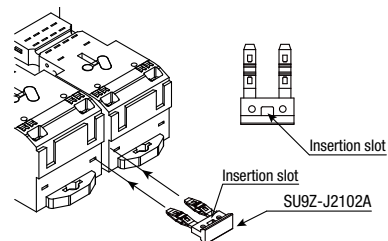

Installing the Release Lever

To install the release lever, SU9Z-S21R (for relay), attach to the protrusion on the socket as shown below.

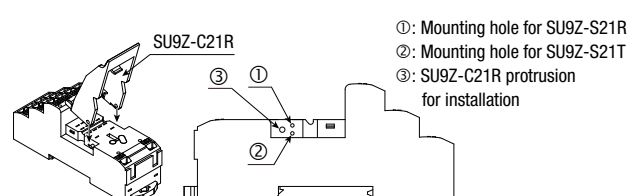

Applicable Relay / Timer

Applicable Relay (RU Series)

Shape	Model	Single Contact		Bifurcated Contact	Coil Voltage Code *	
		Part No. (DPDT)	Part No. (4PDT)	Part No. (4PDT)		
	With Latching Lever	Standard	RU2S- *	RU4S- *	RU42S- *	A24, A100, A110, A200, A220, D6, D12, D24, D48, D100, D110
		With diode (DC coil only)	RU2S-D- *	RU4S-D- *	RU42S-D- *	D6, D12, D24, D48, D100, D110
		With diode (DC coil only) Reverse polarity coil	RU2S-D1- *	RU4S-D1- *	RU42S-D1- *	D24
		With RC (AC coil only)	RU2S-R- *	RU4S-R- *	RU42S-R- *	A100, A110, A200, A220
	Without Latching Lever	Standard	RU2S-C- *	RU4S-C- *	RU42S-C- *	A24, A100, A110, A200, A220, D6, D12, D24, D48, D100, D110
		With diode (DC coil only)	RU2S-CD- *	RU4S-CD- *	RU42S-CD- *	D6, D12, D24, D48, D100, D110
		With diode (DC coil only) Reverse polarity coil	RU2S-CD1- *	RU4S-CD1- *	RU42S-CD1- *	D24
		With RC (AC coil only)	RU2S-CR- *	RU4S-CR- *	RU42S-CR- *	A100, A110, A200, A220

Rated Coil Voltage

Coil Voltage Code	Coil Rating
A24	24V AC
A100	100-110V AC
A110	110-120V AC
A200	200-220V AC
A220	220-240V AC
D6	6V DC
D12	12V DC
D24	24V DC
D48	48V DC
D100	100V DC
D110	110V DC

Applicable Relay (RN Series)

Shape	Part No.		Coil Rated Voltage
	DPDT	4PDT	
	RN2S-NL-A24	RN4S-NL-A24	24V AC
	RN2S-NL-A115	RN4S-NL-A115	115V AC
	RN2S-NL-A220	RN4S-NL-A220	220V AC
	RN2S-NL-A230	RN4S-NL-A230	230V AC
	RN2S-NL-A240	RN4S-NL-A240	240V AC
	RN2S-NL-D12	RN4S-NL-D12	12V DC
	RN2S-NL-D24	RN4S-NL-D24	24V DC
	RN2S-NL-D48	RN4S-NL-D48	48V DC
	RN2S-NL-D110	RN4S-NL-D110	110V DC

Applicable Timer (GT5Y)

Shape	Operation Mode	Contact Configuration	Output	Time Range	Operating Voltage	Part No.
	A: ON Delay B: Interval ON C: Cycle OFF D: Cycle ON	2PDT	220V AC/ 30V DC, 5A	0.1S to 10H	100 to 120V AC	GT5Y-2SN1A100
				0.1S to 30H		GT5Y-2SN3A100
				0.1S to 60H		GT5Y-2SN6A100
				0.1S to 10H	200 to 240V AC	GT5Y-2SN1A200
				0.1S to 30H		GT5Y-2SN3A200
				0.1S to 10H	12V DC	GT5Y-2SN1D12
				0.1S to 30H		GT5Y-2SN3D12
				0.1S to 60H		GT5Y-2SN6D12
				0.1S to 10H	24V DC	GT5Y-2SN1D24
				0.1S to 30H		GT5Y-2SN3D24
		0.1S to 60H	GT5Y-2SN6D24			
		4PDT	220V AC/ 30V DC, 3A	100 to 120V AC	0.1S to 10H	GT5Y-4SN1A100
					0.1S to 30H	GT5Y-4SN3A100
					0.1S to 60H	GT5Y-4SN6A100
				200 to 240V AC	0.1S to 10H	GT5Y-4SN1A200
					0.1S to 30H	GT5Y-4SN3A200
					0.1S to 60H	GT5Y-4SN6A200
				12V DC	0.1S to 30H	GT5Y-4SN3D12
					0.1S to 10H	GT5Y-4SN1D24
					24V DC	0.1S to 30H
0.1S to 60H	GT5Y-4SN6D24					

IDEC CORPORATION

Head Office 6-64, Nishi-Miyahara-2-Chome, Yodogawa-ku, Osaka 532-0004, Japan

 www.idec.com

USA IDEC Corporation
EMEA APEM SAS

Singapore IDEC Izumi Asia Pte. Ltd.
Thailand IDEC Asia (Thailand) Co., Ltd.
India IDEC Controls India Private Ltd.

China IDEC (Shanghai) Corporation
IDEC Izumi (H.K.) Co., Ltd.
Taiwan IDEC Taiwan Corporation

Japan IDEC Corporation

Specifications and other descriptions in this brochure are subject to change without notice.
Information in this brochure is current as of July, 2021.
2021 IDEC Corporation, All Rights Reserved.

EP1720-3

